

# USER GUIDE V1.6



flosense<sup>®</sup>  
BY MOULDPRO



Figure 1 : Magnetic Bracket

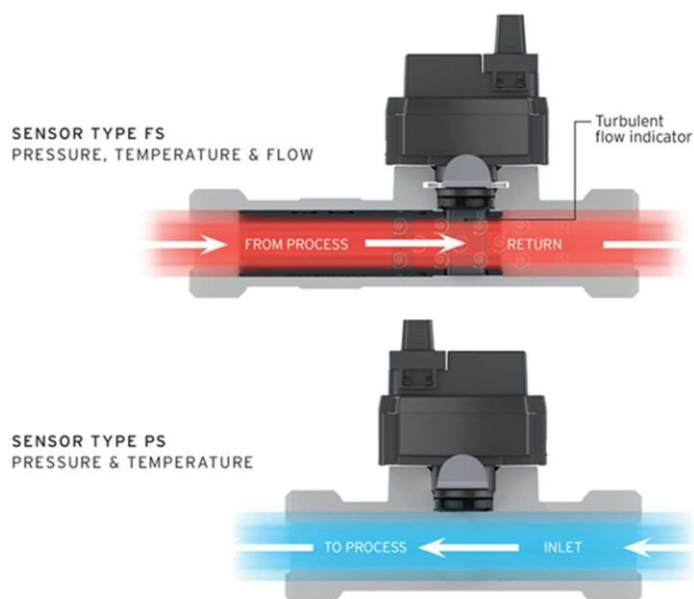

Figure 2 : FloSense Connections

## Connecting the Sensor(s)



*The flow sensor should be placed on the RETURN (OUT) circuit. The pressure sensor (optional) should be placed on the FLOW (IN) Circuit. The unit will automatically scan for the connected sensor during the boot up sequence. If the Sensor is not displaying please go to the information page and press the scan button. See Appendix 6 for further details.*



## Software



*At a glance the user can see the flow conditions; monitoring flow, temperature and pressure. Using the full colour touchscreen, the user can navigate around the intuitive software.*

*In the centre of each dial you can see the actual value of the needle position on the dial and also and additional information related to that parameter. For example, if you press the centre of the temperature dial you will see temperature IN, temperature OUT and also Delta T (the difference between the temperature IN and OUT).*





























*The alarm limits can be seen by the Green alarm band on the scale. The alarm status can be seen by the colour of the bell icon and the centre of each dial will change colour between green, orange (warning), red (alarm).*

*If you are using the Alarm output option, then an alarm signal will be sent when any of the parameters and in alarm condition (red).*

*The flow icon will change to indicate laminar, transitional or turbulaent flow.*

# Graphical Display Symbols



	Graphing Page		Laminar Flow
	Settings Page		Transitional Flow
	Information Page		Turbulent Flow
	Text Display Page		Celsius
	Graphical Display Page		Fahrenheit
	Home		Flow, Litres
	Back		Flow, Gallons
	Flow		Pressure, Pascals
	Temp		Pressure, bar
	Temp IN		Sensor Rescan
	Temp RETURN		Percentage Glycol
	Pressure		Flow Diameter
	Pressure IN		Green Alarm Status
	Pressure RETURN		Red Alarm Status
	Energy BTU		

## Single Sensor Graphic View



## Multi-Sensor Graphic View



Text View Page

A dark blue dashboard with several data points and icons. The data points are displayed in grey boxes with units below them. The icons are in circular frames, some with blue borders and some with red borders.

Icon	Value	Unit
Bar chart		
Gears		
Info		
Pressure gauge		
Wi-Fi	176.3	kPa
Thermometer	-34.5	°F
Wi-Fi	934.2	kPa
Faucet	10.7	gpm
Thermometer	110.5	°F
Bell		
Waves	3589	

# Settings Page, Password / Security Code





# Settings Page, General

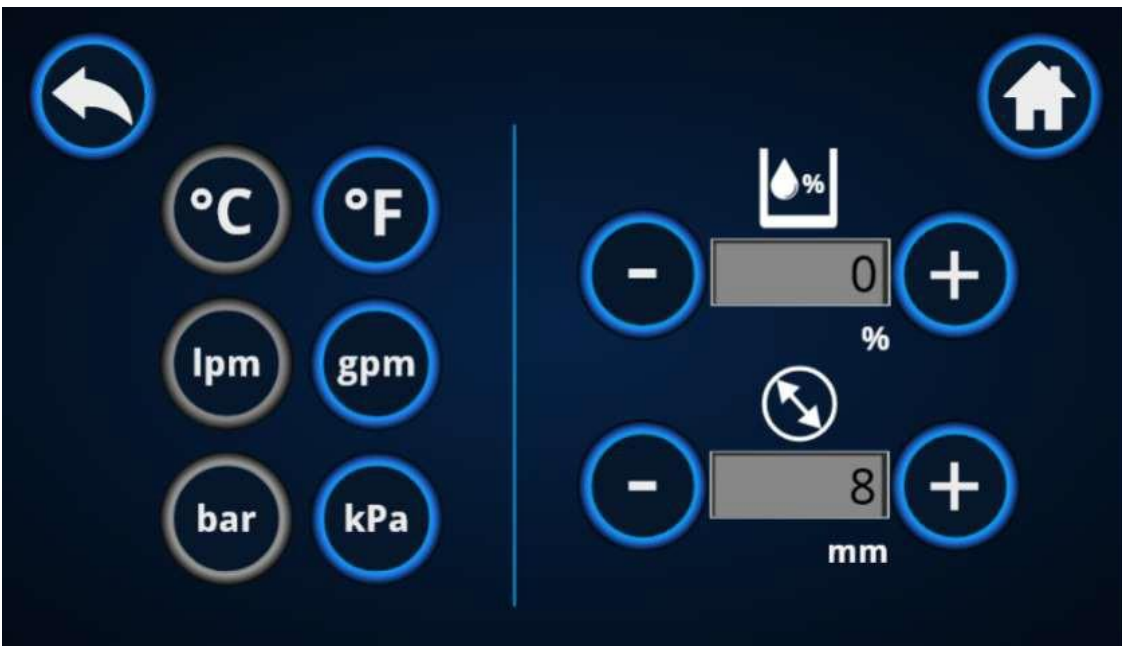

# Settings Page, Flow Alarm Limits



# Settings Page, Pressure Alarm Limits

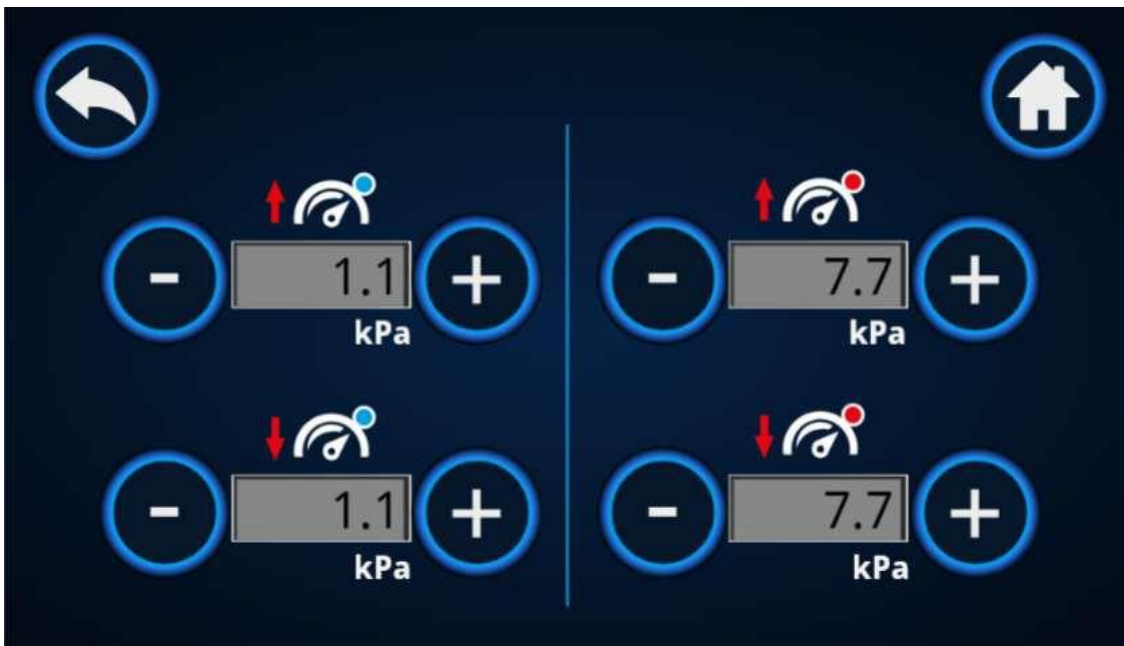

# Settings Page, Temperature Alarm Limits

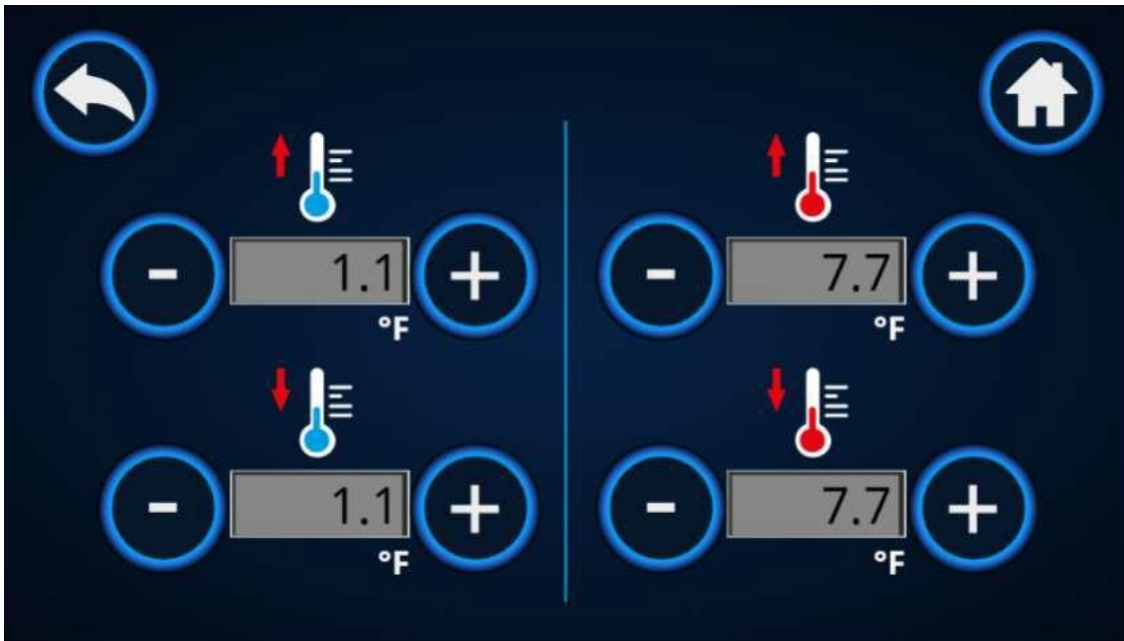

# Graphing Page

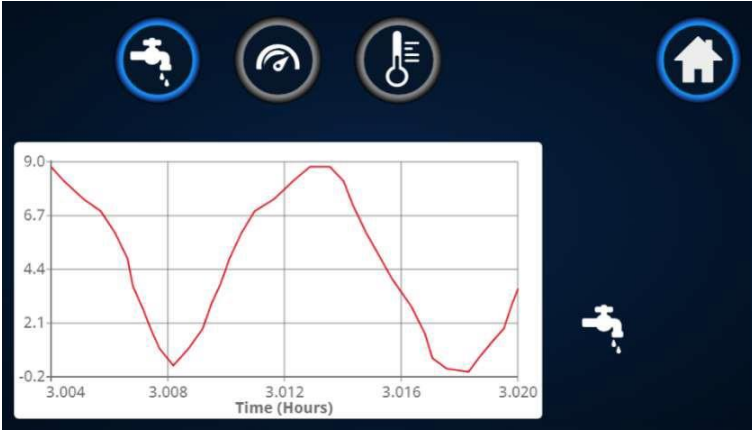

## Information Page



<b>Sensor 1</b>	Serial Number:	984260741172700080
	Version:	V01.04.00
	Product ID:	FS-2-40
	Sensor Range & Display:	2-40
<b>Sensor 2</b>	Serial Number:	984260741172700074
	Version:	V01.04.00
	Product ID:	PS-P10
	Sensor Range & Display:	0-10
<b>Display</b>	Serial Number:	23140001010001C1
	Version:	1.01



Scan here for more help & information

*This Page will display the sensor identification information including Flow / Pressure Range. You can also see the software version and the unit serial number which should be used when contacting for support.*

*If a new sensor is installed the press the scan button if the sensor isn't identified immediately.*

*If there is a problem with the sensor then the error message will be displayed.*

*This page also shows the unit Serial Number and the Software Version*

## Displaying Delta T



*By Pressing the Centre of the Temperature Dial the display will cycle between Temperature IN, Temperature OUT and Delta T (only available on Double Sensor Installations).*

## Displaying Delta P

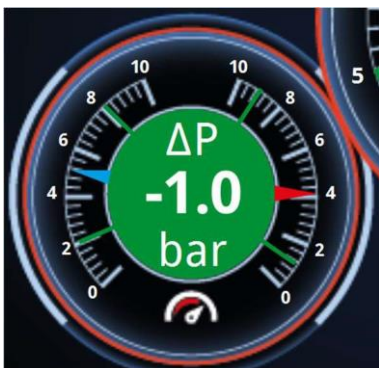
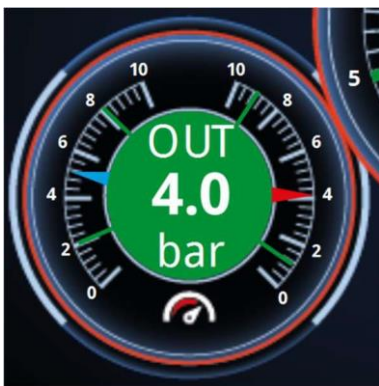

*By Pressing the Centre of the Pressure Dial the display will cycle between Pressure IN, Pressure OUT and Delta P (only available on Double Sensor Installations).*



## Displaying Reynolds Number and Energy (BTU)





*By Pressing the Centre of the Flow Dial the display will cycle between Flow, Reynolds Number and Energy (only available on Double Sensor Installations).*

## Flow Indicator

The unit is capable of displaying the 'type' of flow with a simple icon on the home page which will display laminar, transitional or turbulent flow.



-  Laminar Flow
-  Transitional Flow
-  Turbulent Flow

Essentially, the greater the flow the more efficient the flow and it is always the aim to achieve turbulent flow; in this state the water molecules are 'bouncing' off of the sides of the pipe meaning more effective heat removal of heat from the mould. The measurement of flow is known as a Reynolds (Re) number and this number can be displayed in the centre of the flow dial.



The calculation is based on the diameter of the flow channel and the amount of glycol within in the system; these parameters can be changed on the settings page.



Glycol makes the water / cooling media more viscous which means that more pumping power and consequently more energy is required to achieve turbulent cooling.

# Appendix 1 : FloSense Dimensions

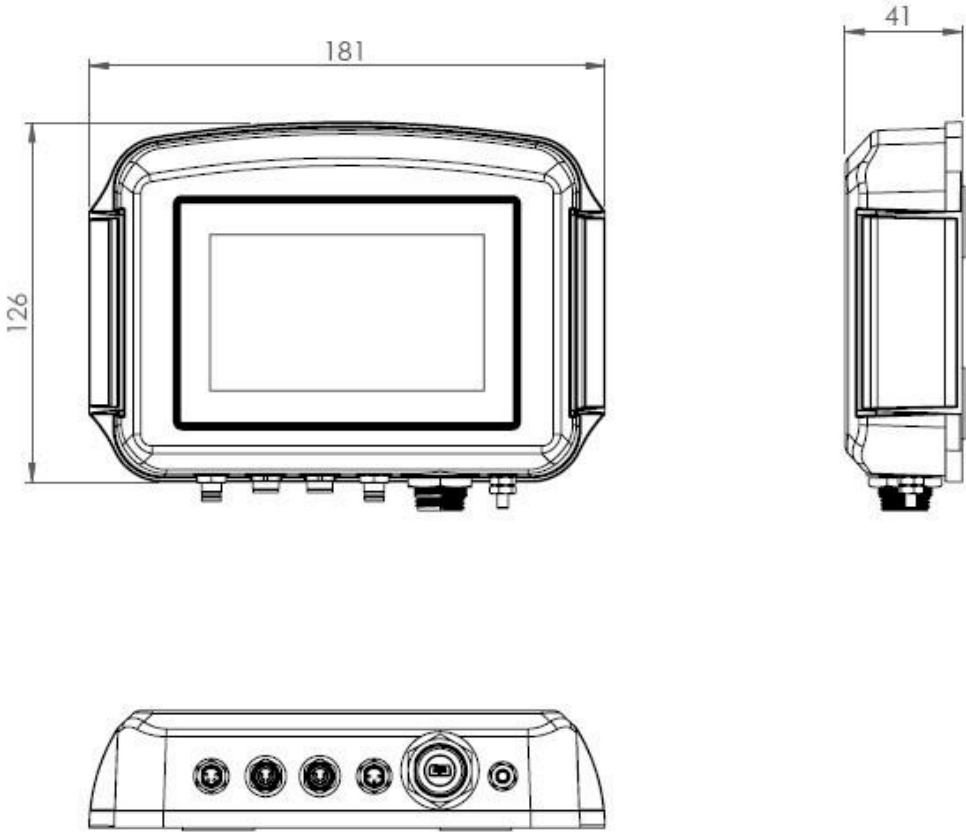

## Appendix 2 : FloSense Ports



*Note : If you notice erratic readings on the screen there may be noise on the sensor signal then connect an earth cable between the Earth stud on the FloSense unit and a hard earth reference point on the pipework.*

## Appendix 3 :Ports Pin Outs

### Sensor



Pin	Description
1	SensorTx
2	0V
3	5V
4	SensorRx

### Alarm



Pin	Description
1	Relay 1 NO
2	Relay 1 COM
3	Future Use (Relay 2 COM)
4	Future Use (Relay 2 NO)

### Power



Pin	Description
1	0V
2	0V
3	9V (V+)

# Appendix 4 : Alarm Output Wiring / Pin Out

Example alarm beacon connection

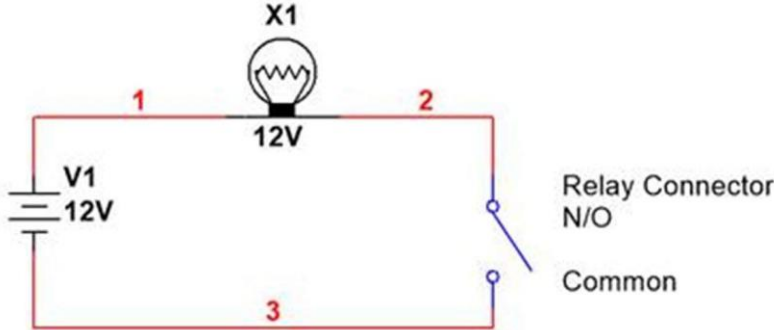

## Appendix 5 : Flow Sensor Options

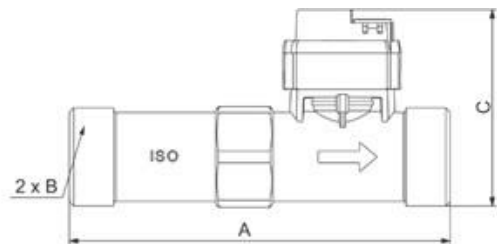

Part No.	Flow capacity l/m	A	B	C	Max Temperature	Hosetail Ref.
FS-115	2-15	110	G 3/4"	58,8	120 °C	CFR3/4-13
FS-240	4-40	110	G 3/4"	58,8	120 °C	HT-316-2 / CFR3/4-19
FS-5100	10-100	129	G 1"	66,5	120 °C	CFR1-25 /CFR1-25
FS-10200	20-200	137,5	G 1-1/4"	74,1	120 °C	HT-316-4



Stainless steel Part No.	Brass Part No.	A1 x D1	Sensor Ref	Part No.
	CFR3/4-13	3/4" X 13	FS-115	GK34
HT-316-2	CFR3/4-19	3/4" X 19	FS-240	
HT-316-3	CFR1-25	1" x 25	FS-5100	GK1
HT-316-4	CFR1.1/4-32	1.1/4 x 32	FS10200	GK114

## Appendix 6 : Sensor Installation

This section gives recommendations on how to design the surrounding piping. Ensure that the sensor flow-pipe and sensor are mounted in the correct flow direction. Please note the “Flow Indicator Arrow” cast on the flow pipe.



**Fig 6.1** Vortex Flow Sensor

To secure optimal measuring conditions for the Vortex Flow Sensor, the following conditions are recommended. Please note, it is of utmost importance to avoid mechanical stress during sensor mounting and when mounting other peripheral mechanical equipment to the sensor. During mounting of the sensor in the flow-pipe, please do not use any kind of grease or organic lubricant. Plain water, soapy water or silicone-based lubricants can be used if necessary, though lubrication should be confined to the sensor-tip and O-ring region. Do not submerge the sensor entirely (IP44).

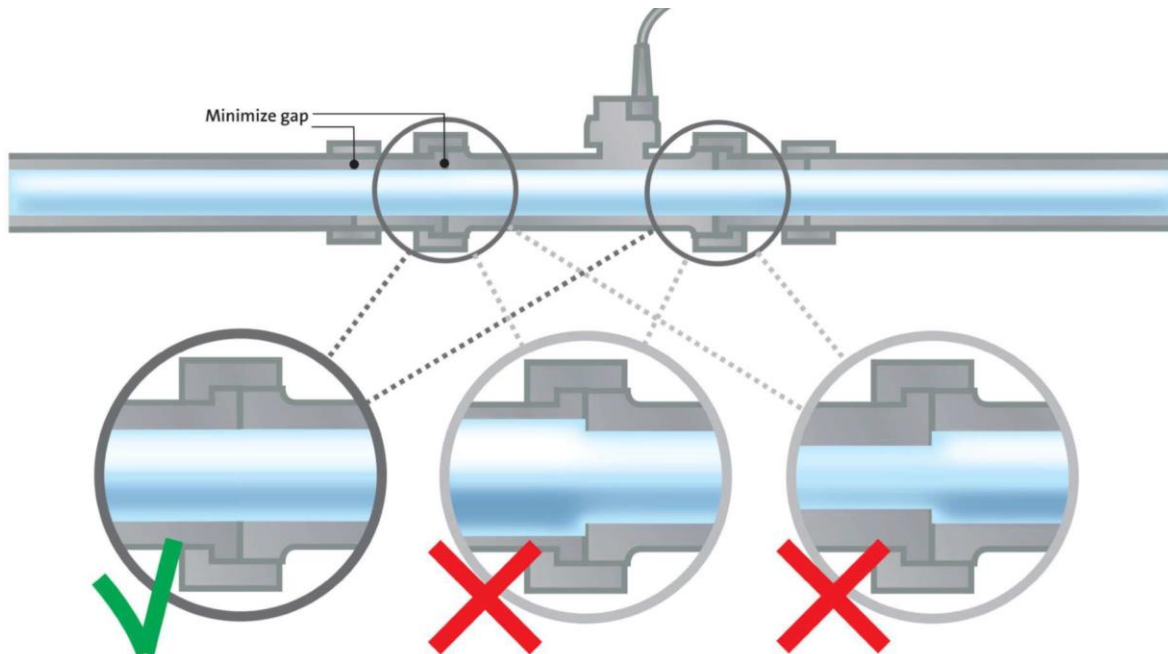

**Fig 6.2** Flow Sensor Mechanical Installation – Avoid changes in bore diameter



## Appendix 6 : Sensor Installation continued

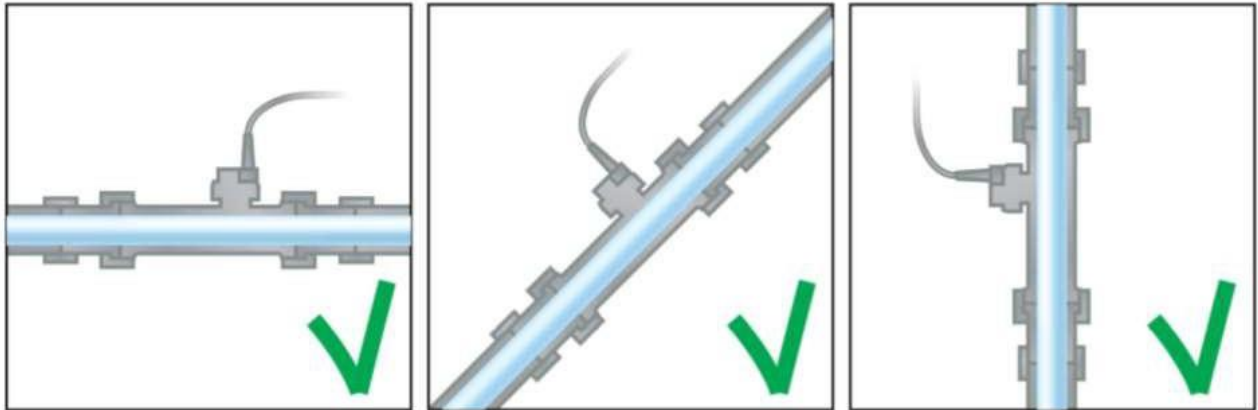

Fig 6.3 Correct Flow Sensor Installation - Orientation

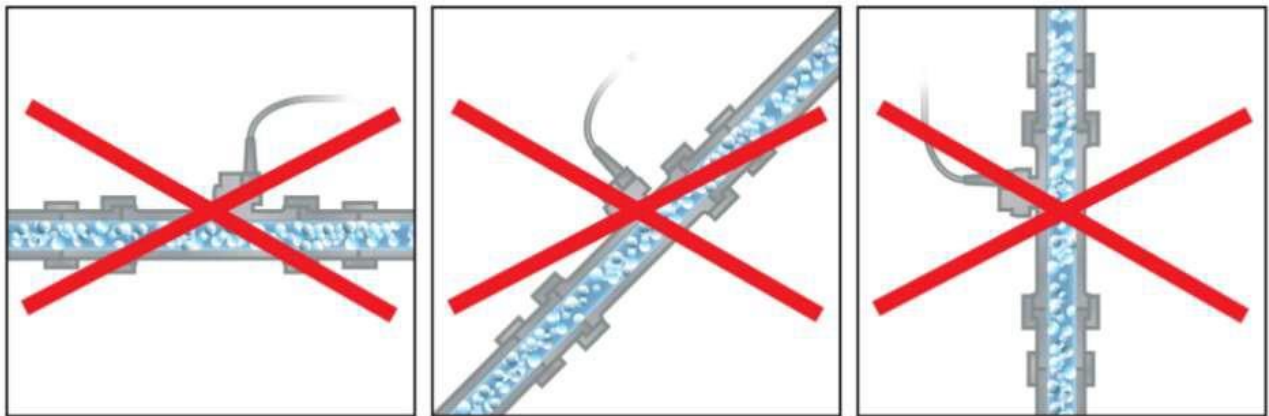

Fig 6.4 Incorrect Flow Sensor Installation – Avoid air in fluid

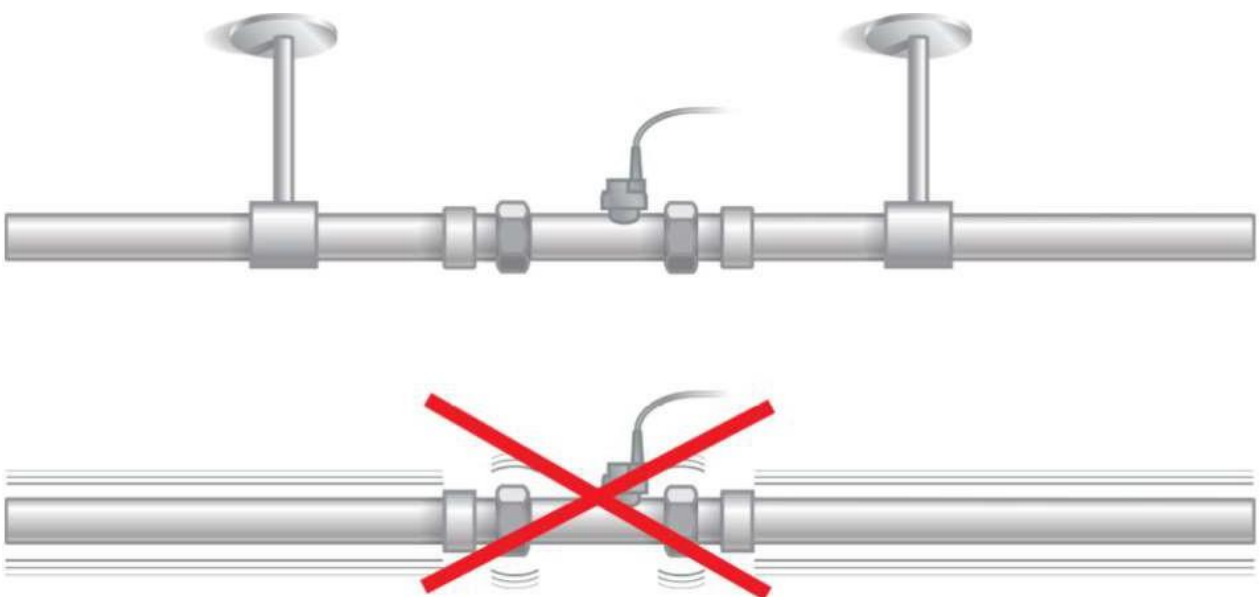
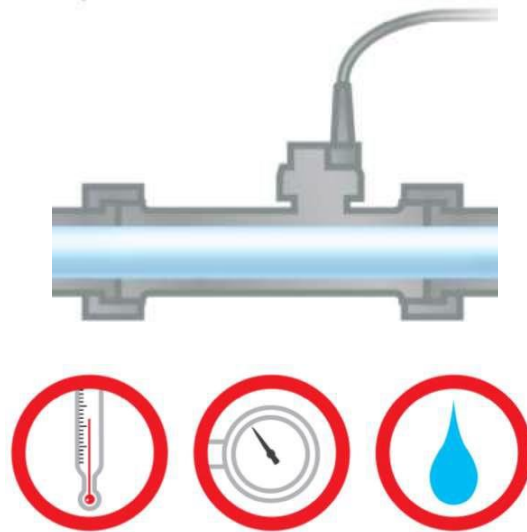

Fig 6.5 Flow Sensor Mechanical Installation – Avoid Vibration

## Appendix 6 : Sensor Installation continued

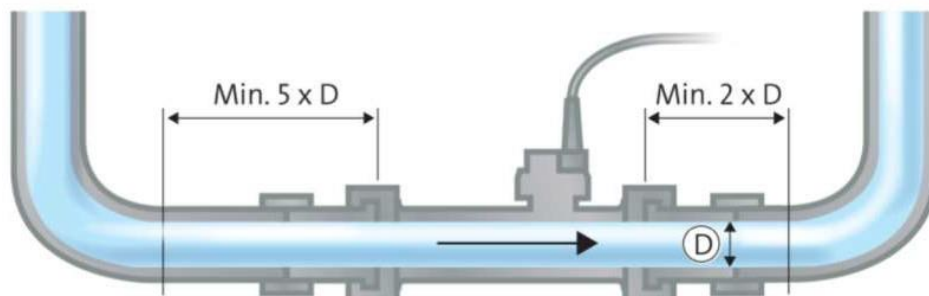

**Fig 6.6** Flow Sensor Operating Conditions

For trouble-free operation and optimal lifetime, the following should be taken into account :

- Do not try to clean the sensor membrane
- Do not tamper or splice the cable
- Evacuation by pressurised air or nitrogen may damage the sensor membrane
- Be aware of the maximum allowed system temperature **MAX 120 Degrees Celsius**
- Freezing liquid will destroy the Sensor Membrane
- Be aware of the maximum allowed system pressure **MAX 10 bar**
- Use the sensor only for the recommended installation – observe standard common practices for flow, pressure and temperature sensors and low voltage electronics **IP44**
- Too high flow, typically 25% higher than  $q_{max}$  will lead to cavitation, which will destroy the sensor membrane

We recommend the following generic piping distances before and after the sensor placement.



**Fig 6.7** Mechanical guideline for flow sensor installation – Distance to bends

## Appendix 7 : Pressure Sensor Installation

For correct pressure measurement only, the sensor can be placed in a T-connector or similar. For correct temperature operation, the sensor should be placed directly in the fluid.

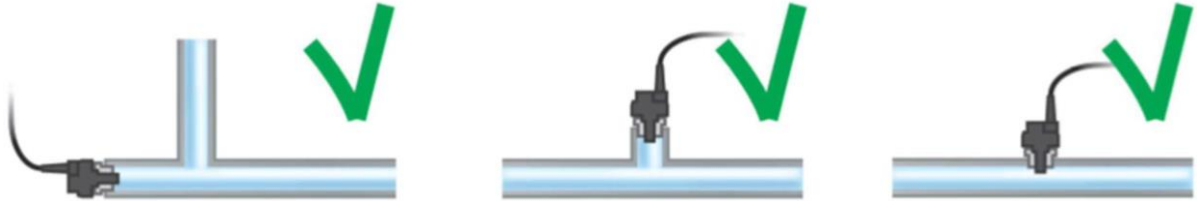

Fig 7.1 : Mechanical guideline for pressure measurement only – Sensor placement.

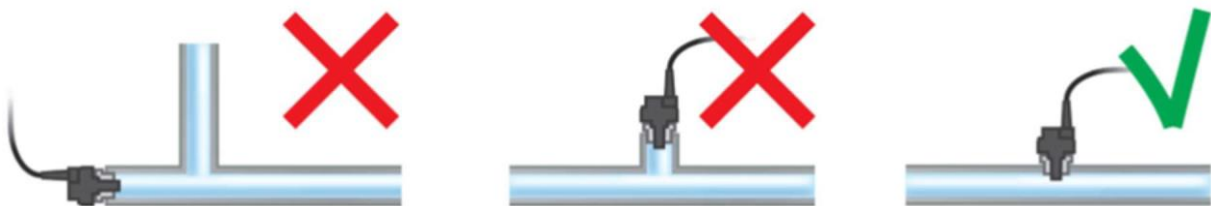

Fig 7.2 : Mechanical guideline for temperature measurement – Sensor placement.

## Appendix 8 : Water Quality

The sensors have been tested and approved for operation in fluid containing high particle levels. The following section outlining water quality should therefore be read as a general precaution in minimising the risk of sensor failure due to excessive sedimentation and obtaining long-term sensor operation.

In some instances, factors related to the water quality of a system can have such an influence that the occurrence of sedimentation in the sensor measurement port of the sensors may have a detrimental effect on the accuracy of the flow or pressure signal of the sensor. This phenomenon usually covers systems where the media is limited to normal water used in oxygen depleted, closed-circuits for heating purposes. For these systems, we recommend the use of sensors with FKM O-rings.

### Organic Content

Organic Content within the media, in the form of grease, oil, lubricants or similar pollutants that may be related to the installation and commissioning of the system, can have an influence on the amount of foreign particles that build-up within the sensor measurement port.

During commissioning of the system, it is recommended that the system in which the sensors are to be operational in is thoroughly flushed to minimise the presence of organic content. Flushing of the system may be performed while the sensor is mounted in the Flow Pipe, though caution should be exercised as not to exceed the maximum, specified flow limit of the sensor.

Likewise, the use of lubricants to assist in mounting the sensor in the flow pipe should also be avoided. Grundfos Direct Sensors are manufactured with a slip coating on the outer O-ring to aid mounting in the flow pipe. Therefore, the use of additional lubricants to assist mounting the sensor in the flow pipe is deemed unnecessary.

It is recommended that the Total Organic Carbon (TOC) content of the media be no greater than 25mg/L.

### pH-Value

Generally, the particle composition of the sedimentation that can be present within a sensor used in closed-circuit heating applications is a combination of iron-oxide and calcium particles. Adjusting the pH-value of the filling media may be necessary to avoid excessive corrosion within the system.

It is recommended that the system media have a pH-value greater than 8. Media below this value should be treated to increase the pH-value which will help minimise the amount of corrosion within the system and the eventual presence of excessive iron-oxide particles.

### Iron-Oxide Content

As the amount of Iron-Oxide (Fe/O) particles present in the water has a direct influence on the amount of particles that are able to deposit in the sensor measurement port, it should be ensured that consideration be given to the causes of corrosion within the system that can lead to excessive Fe/O particles.

As mentioned in the following section, this can be effectively handled by addressing the pH-value of the media for prevention of excessive corrosion as well as flushing the system effectively.

It is recommended that the Fe content of the media be no greater than 10 mg/L.

## Calcium and Magnesium (Total Hardness)

The sedimentation typically present in sensors used within mould cooling circuits is a combination of Fe, O and Ca. The sum of the calcium and magnesium ions in the filling water is influential on the amount of sediments present within the sensor measurement port in the initial operational phase after sensor installation. Consideration to the filling media's total hardness should be given during installation and commissioning.

It is recommended that the total hardness of the filling media be no greater than 100mg/L.

## Recommended Values

The following table outlines the critical factors the customer should be aware of when taking water quality into consideration.

Subject	Value	Unit
pH	>8	
Total Organic Carbon (TOC)	<25	mg/L
Suspended Solids (SS)	<25	mg/L
Iron (Fe)	<10	mg/L
Calcium (Ca) and Magnesium (Mg) – Total Hardness	<100	mg/L

If you have any questions related to this document regarding water quality for your application, please do not hesitate to contact us for further information.

## Glycol

The sensors are designed for flow measurements within glycol or any other additives. However, we do not recommend higher concentration than 42% glycol in water. The temperature must be higher than 30 OC and the kinematic viscosity must be less than 2 mm<sup>2</sup>/s (cSt).

It should be noted that glycol will increase the viscosity at low temperature. Hence, the detectable minimum flow will increase.

## Oil

For aqueous fluid, we recommend the use of EPDM O-rings. If oil is present within the fluid, Grundfos Direct Sensors recommend the use of FKM (Viton) O-rings.

## Extract log data from the device

Flow, temperature and pressure values are logged in the system memory every 6 seconds and stored up to 30 days.

This data can be exported by using the free software to be installed on your PC.

1. [Download](#) the utility software and install on your PC
2. Launch the Device Utility

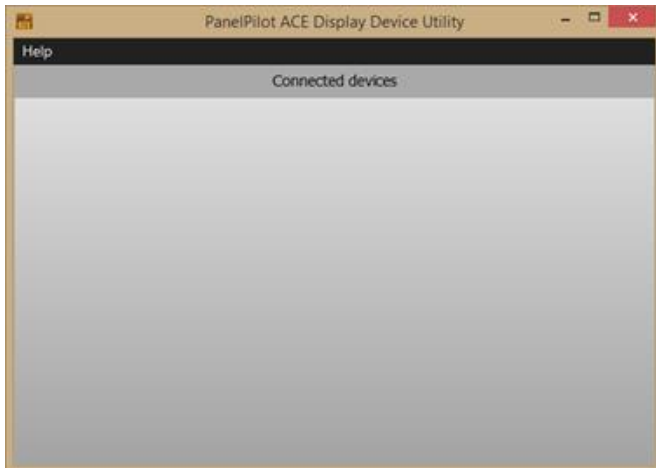

3. Connect your device to the PC using a Mini USB cable and it should appear within the device utility

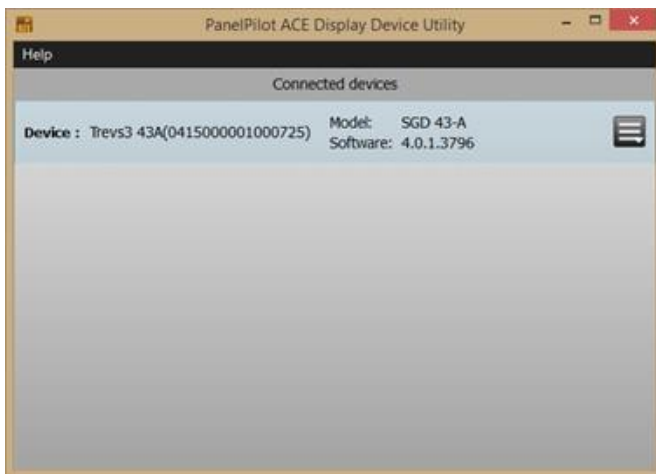

4. Click on the “Burger Menu” next to the device and select “Retrieve Device Logged data”.
5. Select the files and download

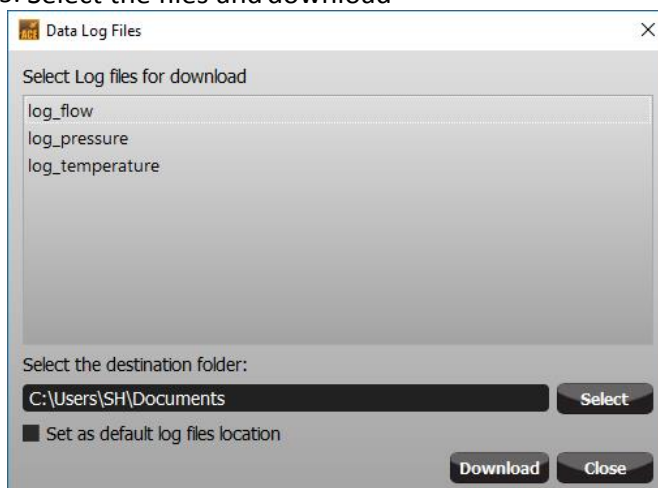

6. Files can be managed by using Excel og similar software to create reports etc.

## Upload New Software

1. [Download](#) the utility software and install on your PC
2. [Download](#) the latest software and unzip it on your PC
3. Launch the Device Utility

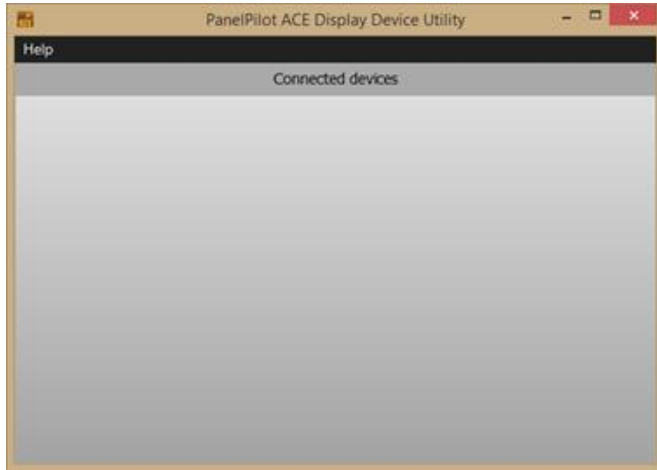

4. Connect your device to the PC using a Mini USB cable and it should appear within the device utility

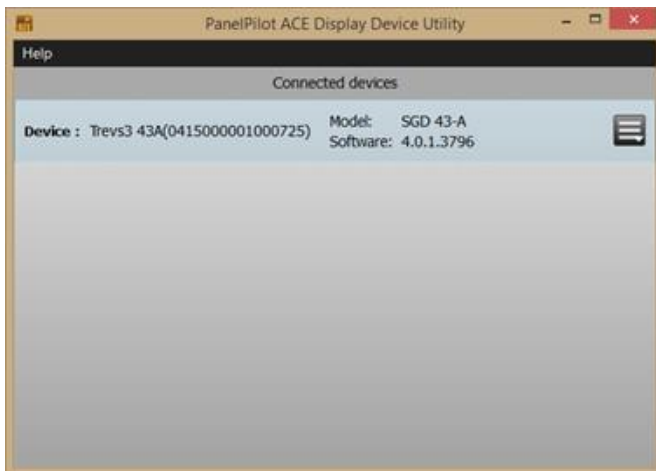

5. Click on the "Burger Menu" next to the device and select "Upload project".

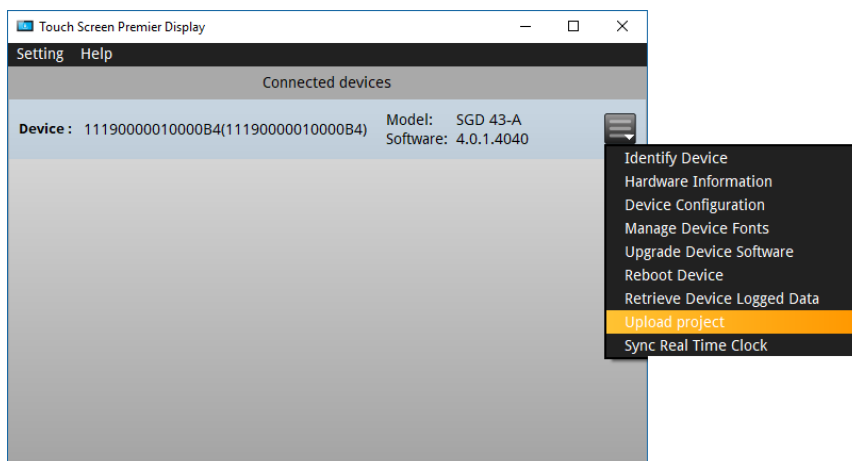

6. Select the file you unzipped on your computer
7. The Flosense Screen will now update and restart.

# Index

*alarm*, 4

**Alarm**, 10, 11, 12

**Alarm Output**

Alarm, 22

**BTU**

kWh, 17

**Calcium**, 29

**Celsius**, 5

**Data extraction**, 29

**Delta P**

Pressure, 16

**Delta T**, 15

Temperature, 15

**Dimensions**, 19

*earth*, 20

**Energy**, 17

Export data, 30

**Fahrenheit**, 5

*FLOW*, 3

*flow sensor*, 3 **Flow**

**Sensor**, 23 *glycol*,

18

**Glycol**, 29 **Graphic**

**View**, 6 **Graphing**

Graph, 13

**Hardness**

Water Hardness, 29

**Information**, 14

**Iron-Oxide**, 28

*laminar*, 4, 18

**Laminar Flow**, 5, 18

**Magnesium**, 29

Magnetic Bracket, 2

**Password**, 8

**pH-Value**, 28

**Pin Outs**

Ports, 21

**Ports**

Connections, 20

*pressure sensor*, 3

**Pressure Sensor Installation**, 27

*RETURN*, 3

*Reynolds*, 18

**Reynolds Number**

Reynolds, 17

*scan*, 14

Security Code, 8

**Sensor Installation**, 24

*Serial Number*, 14

**Settings**, 9

**Software**, 4

*Software Version*, 14

*Software Update*, 30

**Symbols**, 5

**Text View**, 7

*transitional*, 4, 18

**Transitional Flow**, 5, 18

*turbulent*, 4, 18

*turbulent*, 18

**Turbulent Flow**, 5, 18

**Water Quality**, 28



